

BARNWALKER



**SOME HORSES
HAVE ALL THE LUCK!**

barnwalkers.com



CONTENTS

ABOUT US	3
PRODUCTION	4
STALL TYPES	5
PARTITION WALLS	47
WINDOWS	49
DOORS	55
BARN DOORS	59
ACCESSORIES	67
HORSE SOLARIUMS	69
HORSE WALKERS & ROOFS	73
DE SUTTER NATURALLY	79



About Us



From world-class horse shows to your private stables, Barnwalkers is your supplier for high-quality equine equipment. Our products can be found at some of the best horse shows and in many top stables around the world. With decades of experience as passionate equestrians and entrepreneurs we have had the opportunity to explore a large variety of stables while constantly educating ourselves on the best, most reliable products for a barn. We are proud to call ourselves Barnwalkers because there aren't many barns we haven't walked through at some point in our careers.

Through several exclusive partnerships with international manufacturers, we have combined expertise and innovative talent while focusing on horse safety, durability and affordability. Our goal is to share our experience and knowledge to offer our clients a wide variety of quality products and services. We provide turnkey installations done by our team in-house that is experienced and dedicated to Barnwalkers' products.

Bart Kenis

Harry Knopp

BARNWALKER

Smulder



Production

With over 20 years of experience in the industry, Smulders is capable of producing high-quality products for the equine market at very competitive prices.

Smulders production operatives are well-qualified and experienced in both mild and stainless steel fabrication.

We have our own in-house technical and creative department with all of the latest computer-aided drawing technologies.



Our modern state of the art production machines ensure accuracy and efficiency of all of our products.



Stalls

SOME HORSES HAVE ALL THE LUCK!



THE VERY POPULAR SERIES

Sport-Line

This very popular series is well received by both private individuals and professionals and is our most competitively priced range.





Options:

- Doorway without threshold
- Profile 2 inches x 2 inches
- Tube 7/8 inches
- Very strong rail profile
2¹/₄ inches x 2¹/₂ inches
- Board thickness 1¹/₄ inches
- Board height 3 ft 11 inches





Standard version



- hot dip galvanized: NEN-EN-ISO 1461
- width: 10', 12'
- sliding door
- boards type: plastic
- boards height: 3' 11"

Plastic boards



Additional options



- powder coated
- boards type: bamboo or oak
- a small window in the door

Wooden boards



THE SERIES SUITABLE FOR ALL HORSES

Professional Series

The Professional Series was improved in 2016 with our new, very attractive, rounded channel section. This range is suitable for all horses, providing a safe and functional environment.





Some Key Features:

- Doorway without threshold
- Profile $2\frac{3}{8}$ inches x $2\frac{3}{8}$ inches / $2\frac{3}{8}$ inches x $1\frac{1}{12}$ inches
- Tube $1\frac{3}{16}$ inches
- Very strong rail profile $2\frac{1}{4}$ inches x $2\frac{1}{2}$ inches
- Board thickness $1\frac{1}{4}$ inches
- Board height 4 ft 3 inches

BARNWALKER





Standard version



- hot dip galvanized: NEN-EN-ISO 1461
- width: 10', 12', 14'
- sliding door
- boards type: plastic
- boards height: 4' 3"

Plastic boards



Additional options



- powder coated
- boards type: bamboo or oak
- horizontal board: on top/on bottom
- a small window in the door

Wooden boards





VERSION WITH ADDITIONAL OPTIONS

Arched Professional Series



A SERIES OF WAVE TYPE STABLES

Royal Wave

The Royal Wave is the oldest in our range of low-fronted stables with a regal look.

Board thickness 1 ¼ inches/ Board height 4 ft 3 inches.



Options:

- Extra horizontal board
- Bamboo boards
- Ornamental ball or plate
- Stainless steel hinges
- Powder coated
- Bamboo cross in door



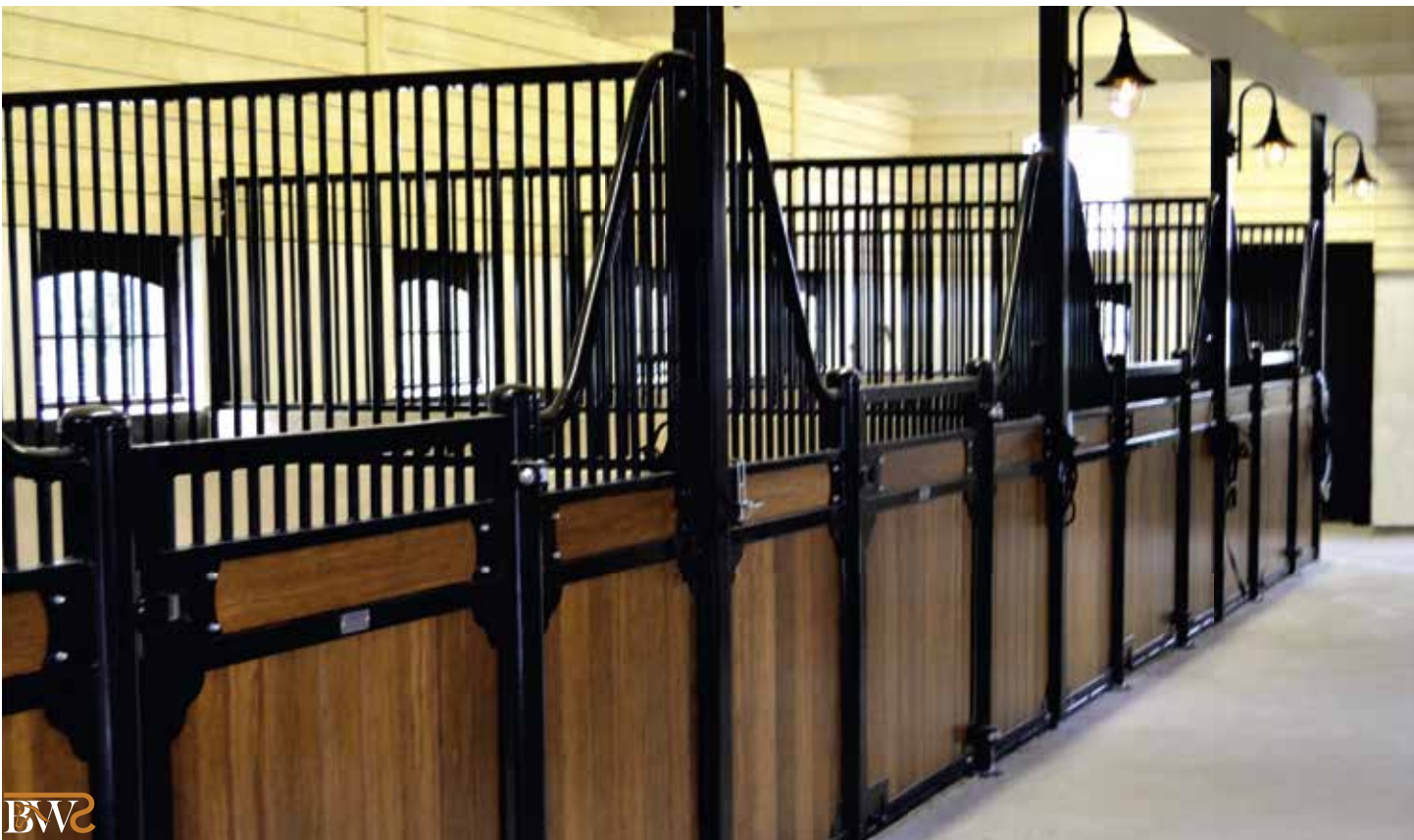

Standard version



- hot dip galvanized: NEN-EN-ISO 1461
- width: 10', 12' 14'
- hinged door
- boards type: plastic
- horizontal board on top
- boards height: 4' 3"

Plastic boards



Additional options



- powder coated
- boards type: bamboo or oak
- horizontal board on the bottom
- cross on door
- openwork boards

Wooden boards



A SERIES OF WAVE TYPE STABLES

Classic Wave

The Classic Wave is another one of our 'Wave' range(s). The lines of this design create a stylish and classic look.

Board thickness 1¼ inches/ Board height 4 ft 3 inches.



Options:

- Stainless steel tubes
- Extra horizontal board
- Bamboo boards
- Ornamental ball or plate
- Stainless steel hinges
- Powder coated
- Bamboo cross in door



Entire Stall Front Fabricated In Stainless Steel





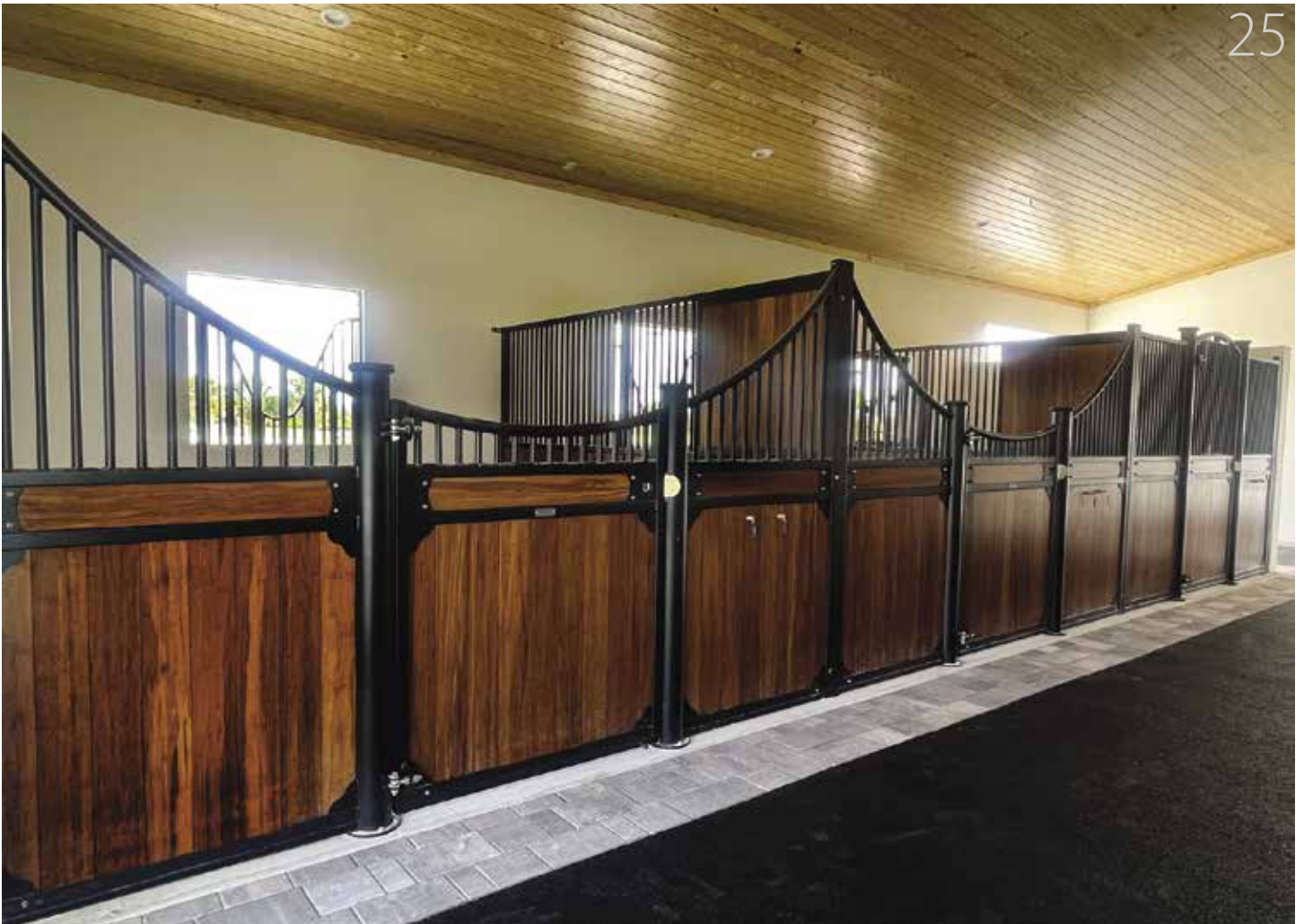

Standard version



- hot dip galvanized: NEN-EN-ISO 1491
- width: 10', 12', 14'
- hinged door
- boards type: plastic
- horizontal board on top
- boards height: 4' 3"

Plastic boards



Additional options



- powder coated
- boards type: bamboo or oak
- horizontal board on the bottom
- ornamental plates or balls
- cross in door
- openwork boards

Wooden boards



Canterbury



ANOTHER OF OUR LUXURY FRONTS

Lexington

The Lexington, just like Windsor and Wave, is another one with the luxury fronts. This range has a central door with unique scrollwork above.
Board thickness 1¼ inches/ Board height 4 ft 3 inches.

Options:

- Stainless steel tubes
- Extra horizontal board
- Bamboo boards
- Ornamental ball or plate
- Stainless steel hinges
- Powder coated
- Bamboo cross in door





THE MOST POPULAR OF LUXURY FRONTS

Windsor

The Windsor is the most popular in our range of luxury stable fronts, a true classic. This front can be customized to suit your specific requirements.
Board thickness 1¼ inches/ Board height 4 ft 3 inches.

Highest
Quality



Windsor

Options:

- Stainless steel tubes
- Extra horizontal board
- Bamboo boards
- Ornamental ball or plate
- Stainless steel hinges
- Powder coated
- Bamboo cross in door







Standard version



- hot-dip-galvanized: NEN-EN-ISO1461
- width: 10' 12' 14'
- hinged door
- board type: plastic
- horizontal board on top
- boards height: 4' 3"

Plastic boards



Additional options



- powder coated
- boards type: bamboo or oak
- horizontal board on the bottom
- ornamental plates or balls
- cross in door
- openwork boards

Wooden boards



Windsor





Entire Stall Front Fabricated In Stainless Steel





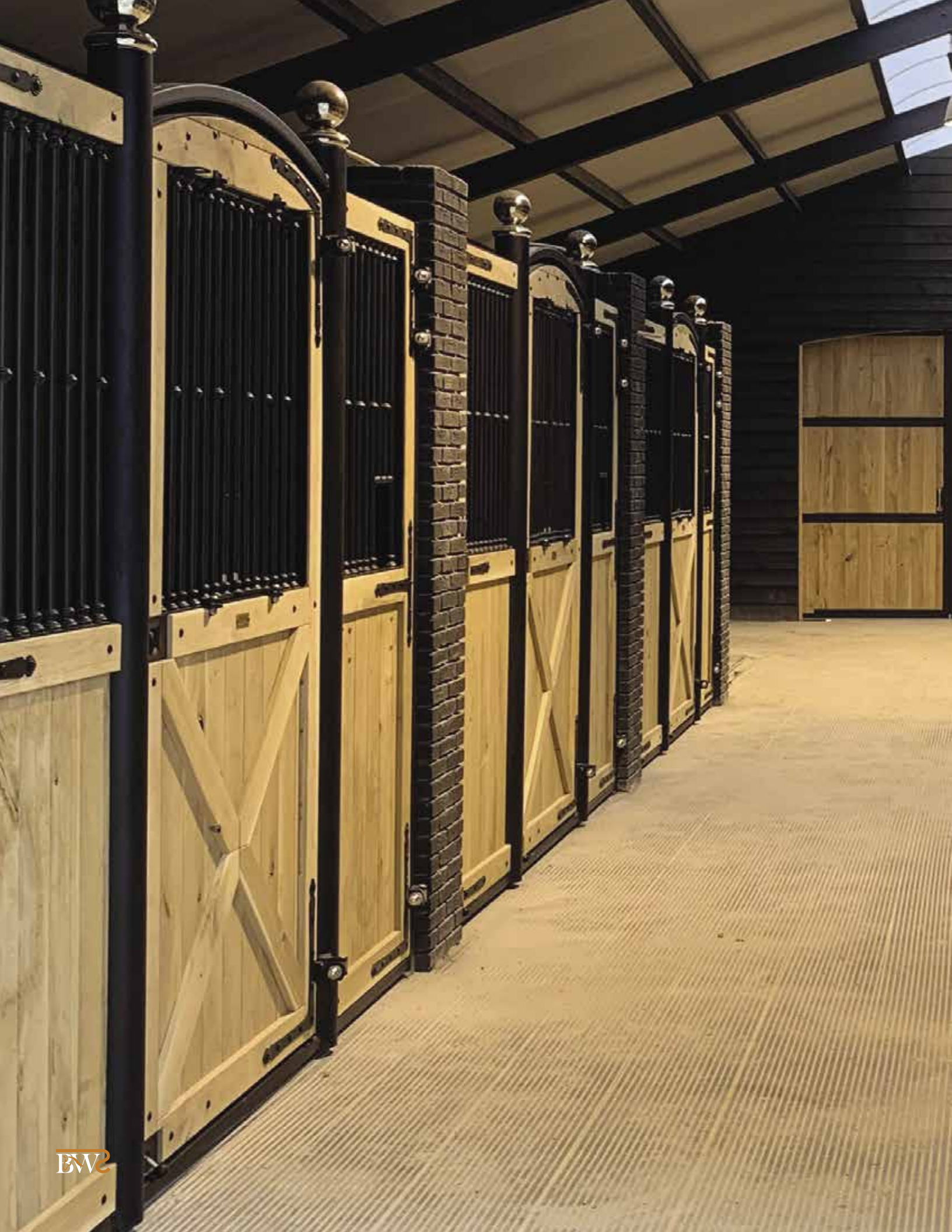

A STYLE THAT REFLECTS THE PAST

Grand Prestige

The Grand Prestige is a nostalgic style that has been modernized with high-quality, cutting-edge materials.

Board thickness 1¼ inches to 2 inches/ Board height 4 ft 3 inches.

Complete Solutions



Grand Prestige

A style which
reflects the past
brought up-to-date
with high-quality
modern materials.



Partition Walls



Partition Walls

We offer a great selection of partition walls for horses. Partition walls with a full grille top, partition walls with a 2/3 grille and privacy panel and solid stall partition walls.



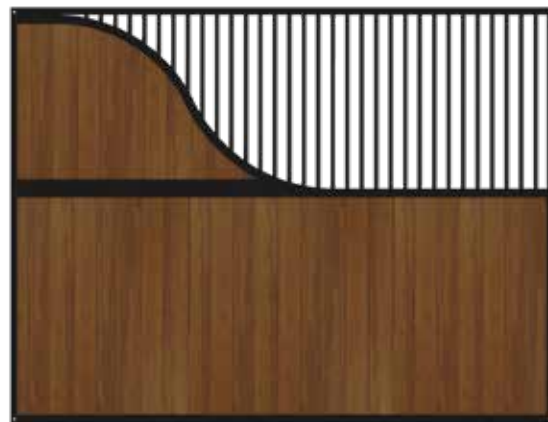
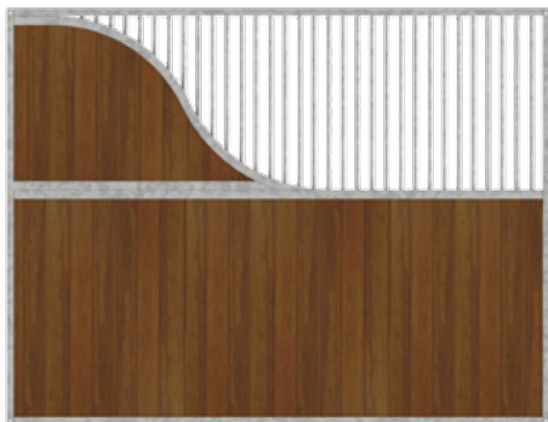
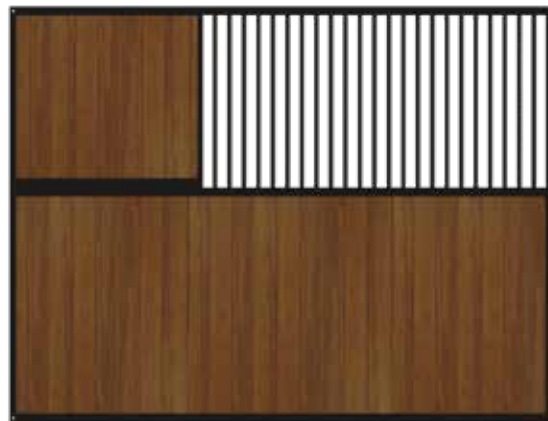
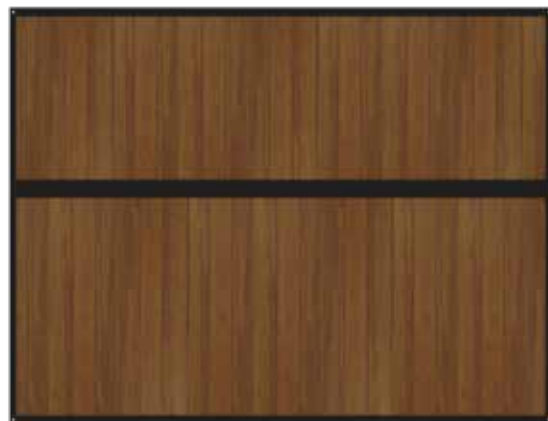
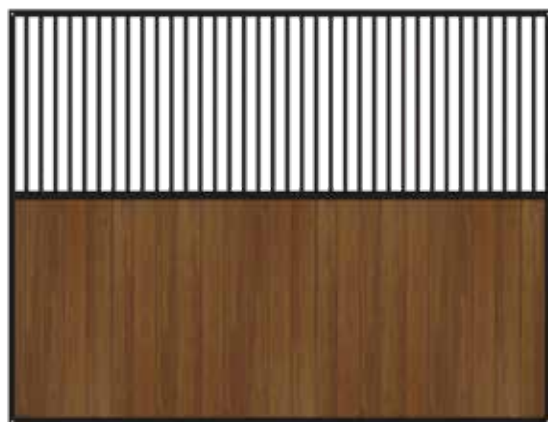

Windows





OUR ATTENTION TO DETAIL MAKES THE DIFFERENCE

Windows

Our attention to detail makes all the difference!

- Frames without sharp edges.
- Lockable stainless steel doorknob.
- Standard safety glass: ¼ inch
- Coated windows and stainless steel hinges.





Closed Windows

The Boards

- Plastic - colors available: brown, black, green, beige, grey, brick red - 1/4 inch thick (thick tongue and groove boards)
- Bamboo in the same specification

Safety Glass Windows

- Tempered glass: 1/4 inch
- Tube diameter: 7/8 inch
- Tilt & turn window

Arched Windows

- Tempered glass: 1/4 inch
- Tube diameter: 7/8 inch
- Tilt & turn window



OUR ATTENTION TO DETAIL MAKES THE DIFFERENCE

Doors

Again, it is our attention to detail that makes all the difference to our comprehensive range of doors.

- All around the frame there are no sharp edges as the angle frame is rounded.
- Lockable stainless steel doorknob.
- Stainless steel two-finger lock that can be opened from the inside or out.
- Standard safety glass ¼ inch.
- Coated windows with stainless steel hinges.



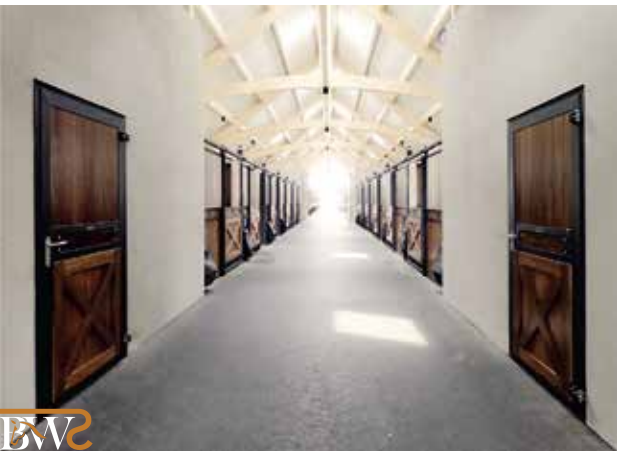

Double Door Fully Cosed

The Boards

- Plastic - colors available: brown, black, green, beige, grey, brick red - 1/4 inch thick (thick tongue and groove boards)
- Bamboo in the same specification
- Coated door with stainless steel hinges

Double Door with Safety Glass

- Safety glass: 1/4 inch
- Tube diameter: 7/8 inch
- Tilt & turn window
- Coated door with stainless steel hinges

Arched Double Door with Safety Glass

- Safety glass: 1/4 inch
- Tube diameter: 7/8 inch
- Tilt & turn window
- Coated door with stainless steel hinges

BARNWALKER



HINGE AND SLIDING DOORS

Barn Doors

Our doors will greatly enhance the external appearance of your building.

- All around the frame there are no sharp edges as the angle frame is rounded.
- Stainless hinges and aluminum locks.
- Standard safety glass ¼ inch.
- Powder-coated doors with stainless steel hinges.

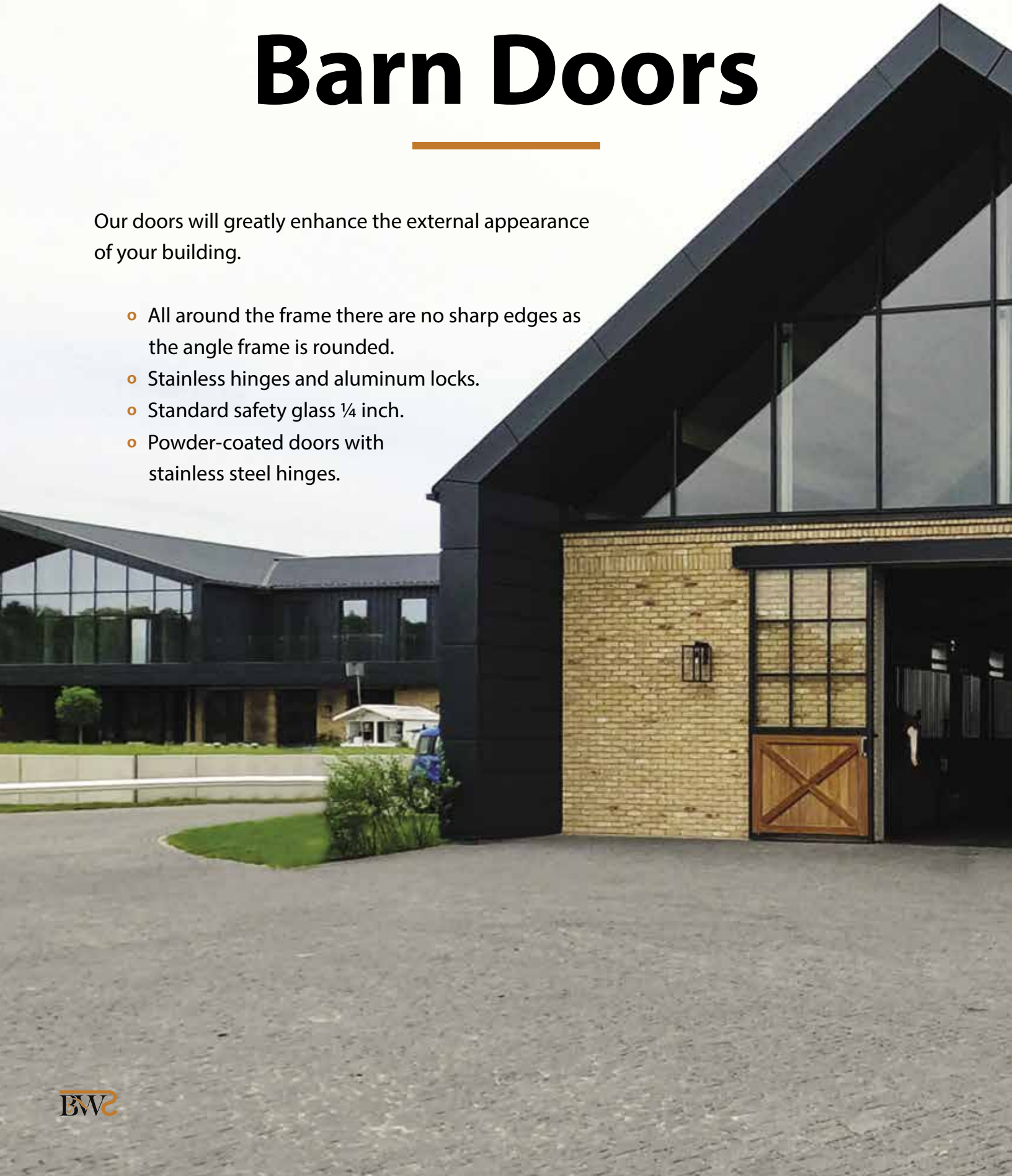







Hinged Doors







Sliding Doors



Accessories



① Wash stall



② Wash stall dividers with storage



③ Tie post



④ Tie ring



⑤ Horse feeder 1



⑥ Horse feeder 2



⑦ Hay rack



⑧ Veterinary 1



⑨ Veterinary 2



⑩ Shower set



⑪ Feed trolley



⑫ Drinking bowl



⑬ Protection brackets for drinking bowl

The Shimon hay bucket



WE OFFER 3 AND 4-PANEL SOLARIUMS

Horse Solariums

A very solid construction. Due to the open construction of the solarium, the moisture given off from the horse is dispersed, so that the efficient working of the infra-red lamps is maintained. Fresh air is sucked in at the rear, allowing equal distribution of warmth around the horse.



We offer 3 and 4-panel solariums at attractive prices. Our solariums are characterized by simple construction and easy attendance. They are equipped with fans that force the appropriate air circulation that prolong lamps' life and what is more, it makes the drying process much faster for the horse.

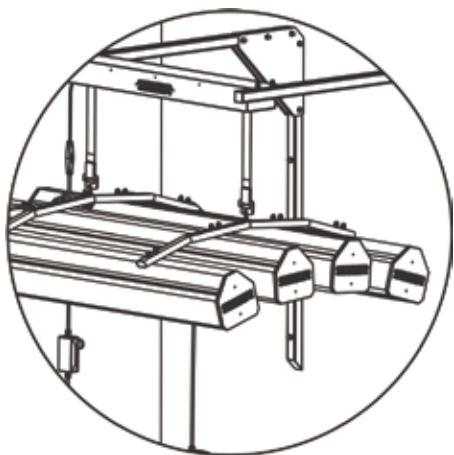

Solarium parameters

- number of heating lamps in one panel: 5
- lamps power: 150W-250W
- number of fans: 1 in each panel
- power: 2616 W (3-panels), 3088 W (4-panels)
- power voltage: 230V
- weight: 3-panels: 108 pounds, 4-panels: 135 pounds

WASH STALLS, TIE POSTS, TIE RINGS, SHOWER SETS...

Around the Solarium

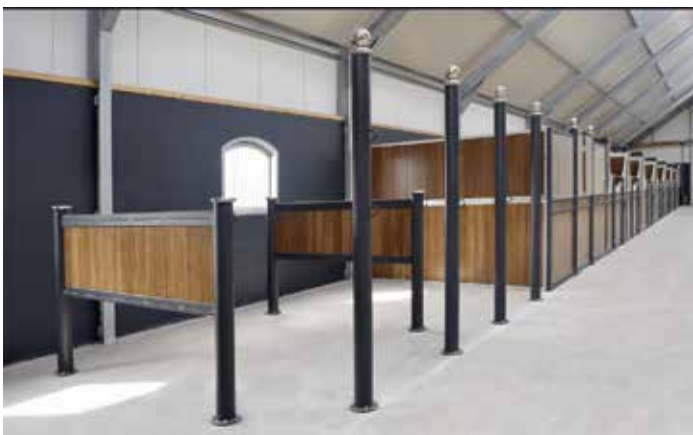

THE PERFECT DEVICE THAT EXERCISES YOUR HORSES

Horse Walkers and Roofs

Our horse walkers are extremely solid, trouble-free and competitively priced. Our standard model is supplied with an attractive horse's head to cap the center post. The engine is mounted under the table, surrounded by protective covers, providing extra safety.





Options:

- Automatic lubrication system
- Control box protective cover
- Pusher gates with 14 aluminum bars instead of 10
- Shock flow set incl. shock flow device
- Mesh aluminum gates





Round Pens

Our round pens are engineered for long-term durability with a pre-rounded, hot-dip galvanized steel frame paired with composite tongue-and-groove boards that will never rot, warp, or splinter. The hot-dip galvanized zinc coating delivers superior protection against rust and weather exposure, making these pens ideal for all climates while ensuring a safe, low-maintenance environment for both horses and handlers.





OUTSTANDING QUALITY FOR EXCEPTIONAL PROPERTIES

De Sutter Naturally

Over 45 years of top quality and exclusivity

The story of De Sutter Naturally began in 1977. Now, over 45 years later, De Sutter Naturally has become the undisputed market leader in Europe for developing, producing and installing horse fences and gates. We deliver the best care, protection and safety for your four-legged friend and an added value for your property.

European reference

De Sutter Naturally is the quality reference in Europe for gates and fencing. Top horsemen from all over Europe have relied on the expertise and the professionalism of De Sutter Naturally for years. Also, international equestrian sport events depend on De Sutter Naturally for a unique appearance and the guarantee of safety. We strive to be the premier provider in Europe and worldwide for premium fences and gates with an authentic rural look.

Our core values

Top quality, safety, durability and service have been the company's key strengths for over 45 years.

Our wooden fences are visually appealing, of high quality, safe and animal-friendly. De Sutter Naturally is the reliable choice for your field. Our durable wood is very easy to maintain and will last for years.

You can choose between different types of wooden fences, all of them guaranteeing exceptional quality. Each type gives your property an exclusive look. Moreover, they all are maintenance free.

To ensure the safety of your horses and/or outdoor animals we manufacture and install our fences without nails or screws. And for the premium fences in tropical hardwood, we offer an anti-rot guarantee of up to 20 years.



PRESSURE-TREATED SOFTWOOD FENCE MODELS

Square

You will enjoy the Square horse fence for years. The square posts are very sturdy and made of top-grade pressure-treated pine from our Densiforce® product range. Not only is the field fence extremely strong and safe, but it also requires no maintenance at all for at least 20 years. In addition, a fence from De Sutter Naturally is always a very tasteful added value for your farm.

Features

- Robust, square posts of 5 x 5 inches.
- Rounded, smooth planed boards that slide through the posts for a solid connection, without dangerous nails or screws.
- Pine wood of the best quality, in Densiforce® green or brown.
- No maintenance required for a minimum service life of 20 years.



PRESSURE-TREATED SOFTWOOD FENCE MODELS

Square Safety



EXCLUSIVE DURABILITY

Tropical Wood

Strong and stylish.

Tropical hardwood: the hardest and most durable type of wood. A fence or gate in tropical hardwood requires no maintenance and can easily last 30 years. Our wooden fences and gates in tropical hardwood offer pure quality and are functional as well as adding visual value to your farm.



TROPICAL HARDWOOD FENCING MODELS

Royal Tropic

Our Royal Tropic fences are a stylish, solid choice as a horse fence. The prestigious look, in combination with the seamlessly joined wood, is an absolute asset for your pasture. In addition, the tropical hardwood grays naturally giving it a beautiful, authentic look that you can enjoy for years.

Features

- Made of tropical hardwood of the highest durability class.
- Smooth, planed square posts of 4 x 4 inches, with rails which are slid through the posts for a solid connection without dangerous screws and nails.
- Prestigious look with diamond-shaped top.
- Authentic and rural look due to the natural graying, which gives the wood a beautiful patina.
- You will enjoy this horse fence for at least 30 years without maintenance.



GUARANTEED SAFETY, MADE OF BEAUTIFUL WOOD WITH AUTHENTIC APPEARANCE

Royal Tropic Safety

This beautiful arena fence with its authentic appearance is made of the sturdiest and most durable tropical hardwood. Due to the natural graying process, the wood will become more beautiful over the years. The solid connection between the boards and posts, as well as the continuous top rail, guarantee extra safety for horses and riders in case of a fall.

Features

- The continuous top rail provides additional safety for horse and rider in the event of a fall.
- Made of the sturdiest and most durable tropical hardwood.
- The wood will turn gray over the years, resulting in a beautiful, authentic look.
- Strong, planed square 4 x 4 inch posts. The boards slide through the posts for a solid connection without nails or screws.
- This horse fence will last you for at least 30 years, without maintenance.



RUSTIC WOODEN GATES

Gates

Natural looking, yet robust and durable. De Sutter Naturally rustic wooden field gates are traditionally and authentically made and give your paddocks and pastures a beautiful added value. They are natural looking yet robust and durable with stainless steel bolts and the choice of wood used. The durability class 1 tropical hardwood remains beautiful for decades and is a perfect match for our authentic agricultural fencing.

- A field gate made according to traditional and authentic methods. You can recognize our Field Gates by the hot-branded De Sutter Naturally mark.
- Made of the strongest tropical hardwood with durability class 1. This gives our gates the necessary robustness.
- Solid construction thanks to the pin-and-hole connection.
- The safety bolts are made of stainless steel and the top rail is chamfered to allow water to run off.
- Life span of minimum 30 years.





De Sutter Naturally Round Pens





Contact Info

Bart Kenis

Bart@barnwalkers.com

O: 561.486.0583

C: 561.568.2295

Harry Knopp

Harryk@idadevelops.com

O: 561.486.8406



13833 Wellington Trace, Suite E1 & E2,
Wellington, FL 33414
Office: 561.486.0502



Smulderz

BARNWALKERZ

S T A L L S • W A L K E R S

